



深圳市华远显示器件有限公司  
SHENZHEN HUAYUAN DISPLAY CO.,LTD.

---

# 液晶显示模块规格书

Specification for Liquid Crystal Display Module

HYC160210C-bT62L-VA

Prepared By	Reviewed By	Approved By
Date:	Date:	Date:



Title HYC160210C-bT62L-VA.doc SPECIFICATION	DOC#:	Rev. : R00
	Effective Date: 2011-11-20	

## REVISION HISTORY

The following table tracks the history of the changes made to this document.

SN	Rev.	Content	Date	Design
1	R00	Origin Released	2011-11-20	



Title HYC160210C-bT62L-VA.doc SPECIFICATION	DOC#:	Rev. : R00
	Effective Date: 2011-11-20	

# CONTENTS

REVISION HISTORY	2
CONTENTS	3
1.0 GENERAL DESCRIPTION	4
2.0 FEATURES	4
3.0 MECHANICAL SPECIFICATION	4
4.0 BLOCK DIAGRAM	5
5.0 EXTERNAL DIMENSIONS	6
6.0 INTERFACE PIN DESCRIPTIONS	7
7.0 ABSOLUTE MAXIMUM RATINGS	8
8.0 ELECTRICAL CHARACTERISTICS	8
9.0 OPTICAL CHARACTERISTICS	9
10.0 TIMING CHARACTERICS	11
11.0 BACKLIGHT CHARACTERISTICS	13
12.0 OPERATING PRINCIPLES & METHODS	14
13.0 INSTRUCTION DESCRIPTION	16
14.0 QUALITY GUARANTEE	21
15.0 RELIABILITY	26
16.0 PRECAUTIONS FOR USING LCD MODULES	27
17.0 USING LCD MODULES	29
18.0 APPENDIX	33

	Title HYC160210C-bT62L-VA.doc SPECIFICATION	DOC#:	Rev. : R00
		Effective Date: 2011-11-20	

## 1.0 GENERAL DESCRIPTION

The **HYC160210C-bT62L-VA** is a **16x2** characters dot-matrix LCD module. It has a **STN** panel composed of **80** segments and **16** commons. The LCM can be easily accessed by microcontroller via **6800 series** interface.

## 2.0 FEATURES

Display Format	16 Characters × 2 Lines
LCD Type	STN-BLUE-NEGATIVE
Polarizer Mode	TRANSMISSIVE
Drive Method	1/16 Duty, 1/5 Bias
Viewing Direction	6 O'clock
Controller	ST7066U-0A
Interface	8-Bit Parallel Interface (6800 Series)
Backlight	WHITE LED Backlight

## 3.0 MECHANICAL SPECIFICATION

Item	Description	Unit
Module Dimension	85.0(W) × 30.0(H) × 14.0(Max)(T)	mm
Viewing Area	64.6(W) × 16.0(H)	mm
Active Area	55.73(W) × 10.98(H)	mm
Dot Size	0.50(W) × 0.55(H)	mm
Dot Pitch	0.57(W) × 0.62 (H)	mm
Character Size	2.78(W) × 4.89 (H)	mm



## 4.0 BLOCK DIAGRAM

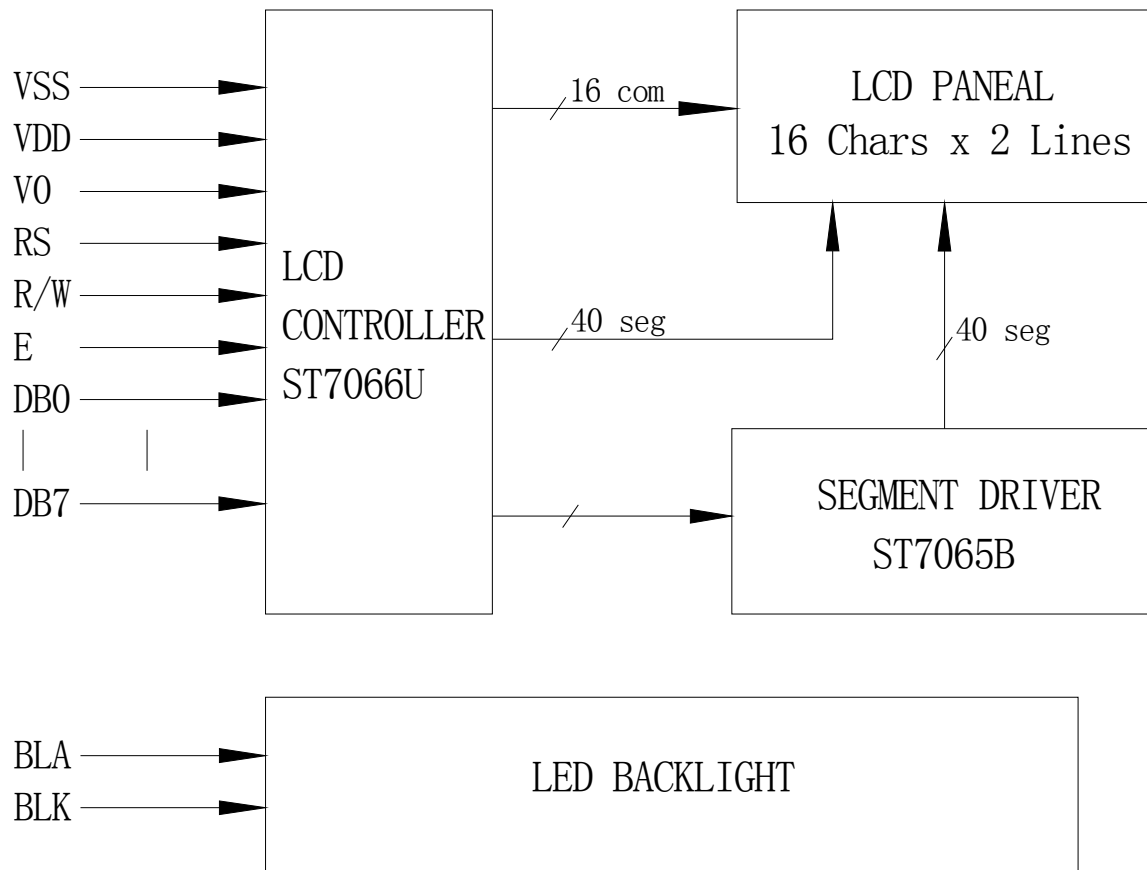

## 5.0 EXTERNAL DIMENSIONS

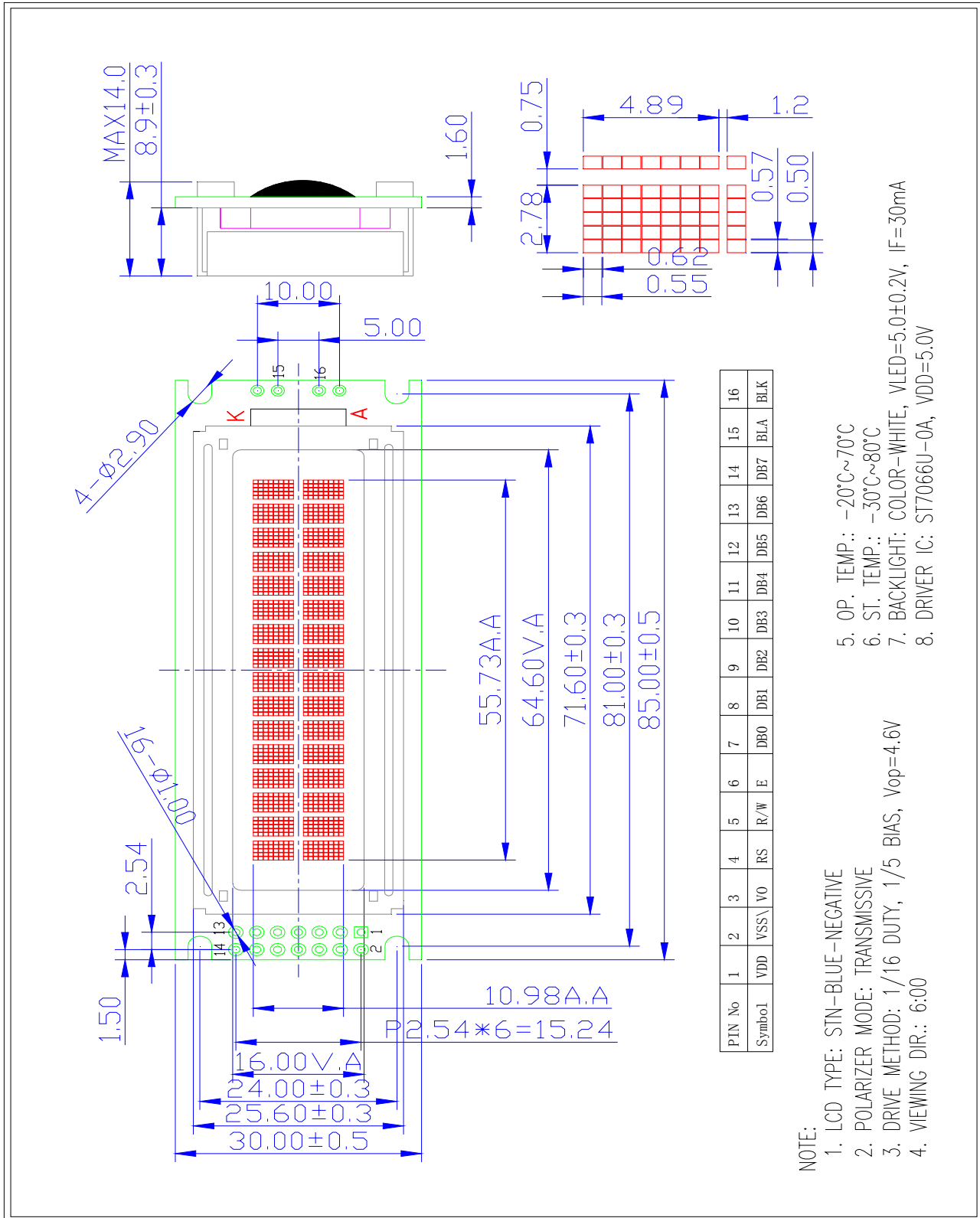



Title HYC160210C-bT62L-VA.doc SPECIFICATION	DOC#:	Rev. : R00
	Effective Date: 2011-11-20	

## 6.0 INTERFACE PIN DESCRIPTIONS

PIN No.	Symbol	Level	Description
1	V <sub>DD</sub>	P	Power supply for logic(+5.0V)
2	V <sub>SS</sub>	P	Ground
3	V <sub>0</sub>	P	Power supply for LCD
4	RS	H/L	Select registers. 0: Instruction register (for write) Busy flag: address counter (for read) 1: Data register (for write and read)
5	R/W	H/L	Select read or write. 0: Write 1: Read
6	E	H,H→L	Starts data read/write. Read data when E is “H” ; Write data at the falling edge of E
7	DB0	H/L	Data Bit0
8	DB1	H/L	Data Bit1
9	DB2	H/L	Data Bit2
10	DB3	H/L	Data Bit3
11	DB4	H/L	Data Bit4
12	DB5	H/L	Data Bit5
13	DB6	H/L	Data Bit6
14	DB7	H/L	Data Bit7
15	BLA	P	Power supply for LED Backlight (+5.0V)
16	BLK	P	Power supply for LED Backlight (0V)



## 7.0 ABSOLUTE MAXIMUM RATINGS

Item	Symbol	Min.	Max.	Unit
Supply Voltage (Logic)	$V_{DD}-V_{SS}$	-0.3	7.0	V
Supply Voltage (LCD)	$V_{DD}-V_0$	3.0	10.0	V
Input Voltage	$V_I$	-0.3	$V_{DD}+0.3$	V
Operating Temperature	$T_{opr}$	-20	70	°C
Storage Temperature	$T_{stg}$	-30	80	°C

## 8.0 ELECTRICAL CHARACTERISTICS

Parameter	Symbol	Condition	Min	Typ	Max	Unit
Supply voltage for Logic	$V_{DD}$	---	4.5	5.0	5.5	V
Supply current for Logic	$I_{DD}$	$f_{OSC} = 270KHz$ $V_{DD}=5.0V$	--	0.2	0.5	mA
LCD Operating Voltage	$V_{DD}-V_5$	-20°C				V
		+25°C	4.5	4.6	4.8	V
		+70°C				V
Input voltage H level	$V_{IH}$	---	$0.7V_{DD}$	---	$V_{DD}$	V
Input voltage L level	$V_{IL}$	---	0	---	0.6	V
Output High Voltage	$V_{OH}$	$I_{OH}=-0.1mA$	3.9	---	$V_{DD}$	V
Output Low Voltage	$V_{OL}$	$I_{OL}=0.1mA$	0	---	0.4	V
Frame Frequency	Fr			70	85	Hz



## 9.0 OPTICAL CHARACTERISTICS

Item	Symbol	Condition	Min	Typ	Max	Unit
Response time	Ton	$\theta=0^\circ$ and $T_a=-20^\circ\text{C}$		--		ms
		$\theta=0^\circ$ and $T_a=+25^\circ\text{C}$		--		ms
		$\theta=0^\circ$ and $T_a=+70^\circ\text{C}$		--		ms
	Toff	$\theta=0^\circ$ and $T_a=-20^\circ\text{C}$		--		ms
		$\theta=0^\circ$ and $T_a=+25^\circ\text{C}$		--		ms
		$\theta=0^\circ$ and $T_a=+70^\circ\text{C}$		--		ms
Contrast ration	CR(MAX)	$25^\circ\text{C}$	5	10		---
Viewing Angle	$\emptyset$	Deg $\theta=0^\circ$	$\text{CR} \geq 2.0$ $T_a=25^\circ\text{C}$		50	Deg
		Deg $\theta=90^\circ$			35	
		Deg $\theta=180^\circ$			30	
		Deg $\theta=270^\circ$			35	
Crosstalk		$T_a=25^\circ\text{C}$		1.2		---

### 9.1 Viewing Angle $\theta$ , $\emptyset$ and Viewing Angle Range: $\Delta \emptyset = |\emptyset_2 - \emptyset_1|$

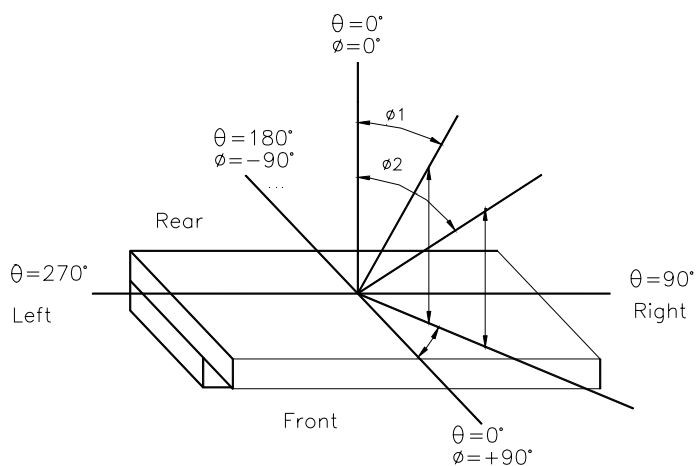

### 9.2 Contrast ratio(CR)

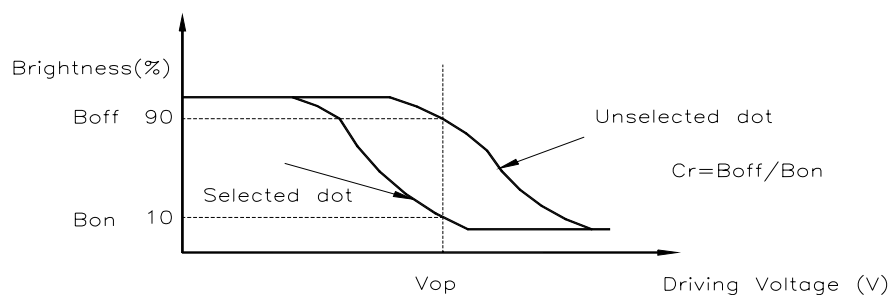

### 9.3 Response Time

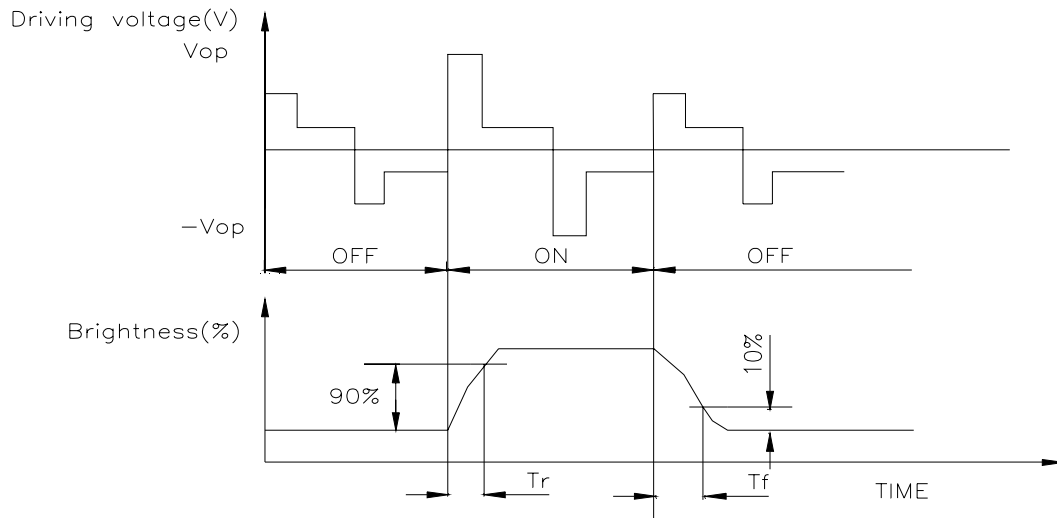

### 9.4 Optical Measurement System

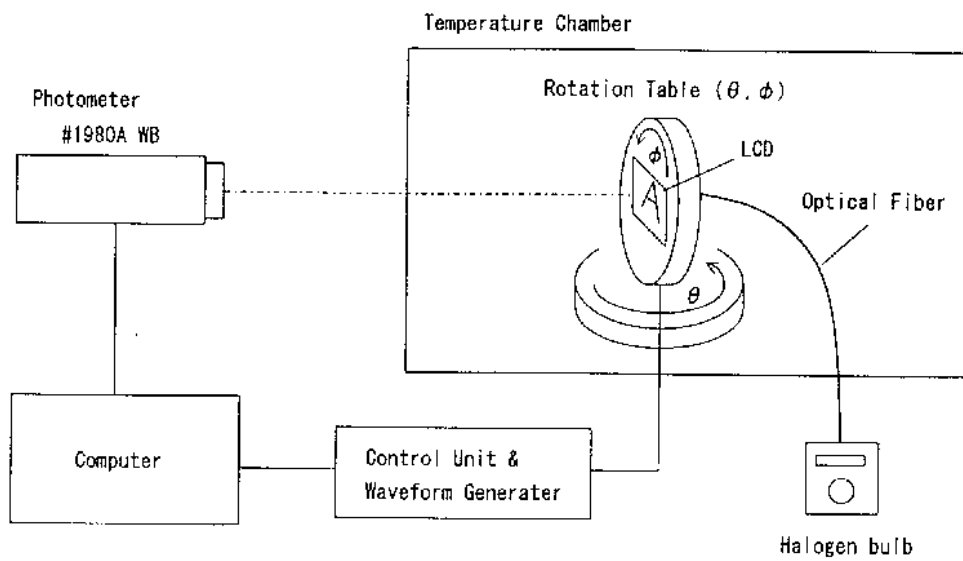



## 10.0 TIMING CHARACTERICS

### 10.1 MPU INTERFACE TIME CHART

Symbol	Characteristics	Test Condition	Min.	Typ.	Max.	Unit
Internal Clock Operation						
fOSC	OSC Frequency	R = 91KΩ	190	270	350	KHz
External Clock Operation						
fEX	External Frequency	-	125	270	410	KHz
TR,TF	Rise/Fall Time	-	-	-	0.2	ms
Write Mode						
TC	Enable Cycle Time	Pin E	1200	-	-	ns
TPW	Enable Pulse Width	Pin E	140	-	-	ns
TR,TF	Enable Rise/Fall Time	Pin E	-	-	25	ns
TAS	Address Setup Time	Pins: RS,RW,E	0	-	-	ns
TAH	Address Hold Time	Pins: RS,RW,E	10	-	-	ns
TDSW	Data Setup Time	Pins: DB0 - DB7	40	-	-	ns
TH	Data Hold Time	Pins: DB0 - DB7	10	-	-	ns
Read Mode						
TC	Enable Cycle Time	Pin E	1200	-	-	ns
TPW	Enable Pulse Width	Pin E	140	-	-	ns
TR,TF	Enable Rise/Fall Time	Pin E	-	-	25	ns
TAS	Address Setup Time	Pins: RS,RW,E	0	-	-	ns
TAH	Address Hold Time	Pins: RS,RW,E	10	-	-	ns
TDDR	Data Setup Time	Pins: DB0 - DB7	-	-	100	ns
TH	Data Hold Time	Pins: DB0 - DB7	10	-	-	ns
TDM	M Delay Time	Pin: M	0	-	2000	ns

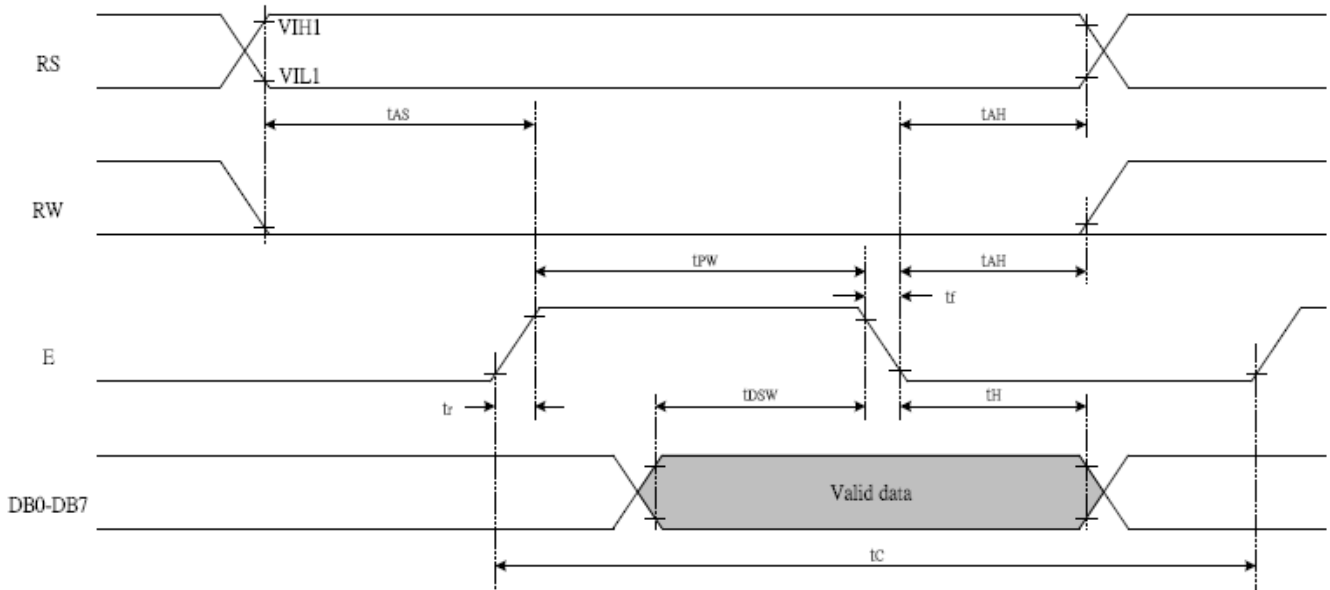

**Write data mode**

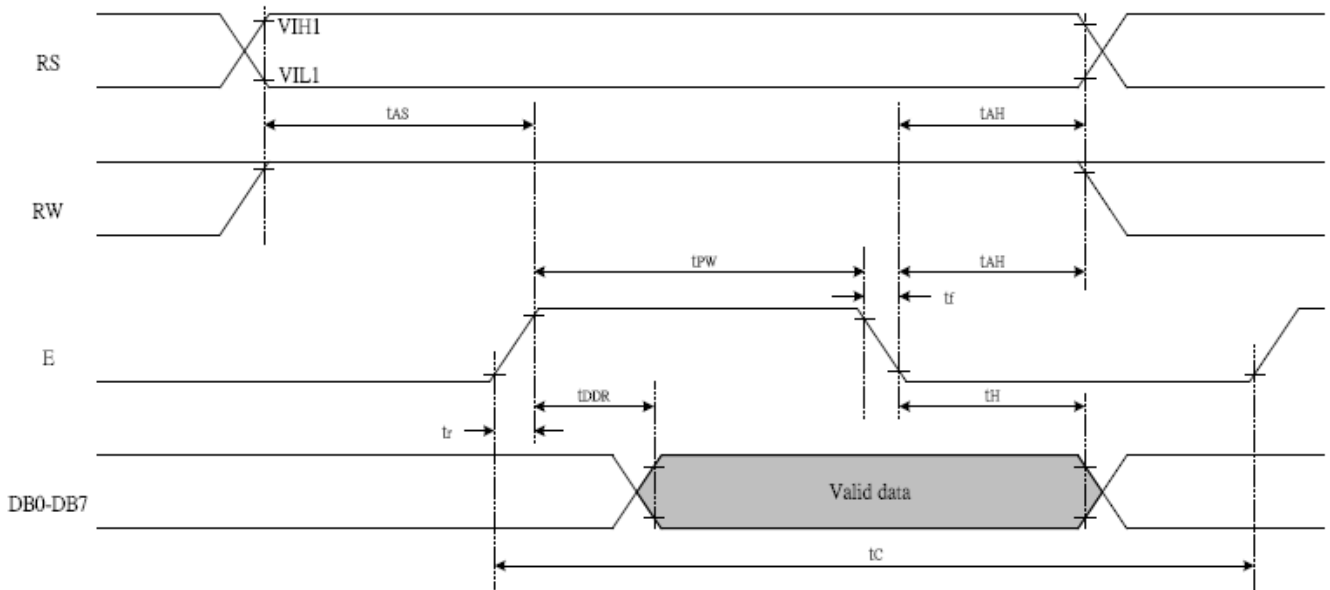

**Read data mode**



Title HYC160210C-bT62L-VA.doc SPECIFICATION	DOC#:	Rev. : R00
	Effective Date: 2011-11-20	

## 11.0 BACKLIGHT CHARACTERISTICS

### 11.1 ABSOLUTE MAXIMUM RATINGS

(Ta=25°C)

Item	Symbol	Condition	Rating	Unit
Reverse Voltage	Vr		5.0	V
Absolute maximum forward current	Ifm		40	mA
Forward Current	If	Vf=5.0V	30	mA
<b>Power Description</b>	Pd		90	mW
Operating temperature range	Topr		-20~+70	°C
Storage temperature range	Tst		-30~+80	°C

For operation above 25°C ,The Ifm Ifp & Pd must be derated ,the Current derating is  $-0.36 \times 24\text{mA}/^\circ\text{C}$  for DC drive and  $-0.86 \times 24\text{mA}/^\circ\text{C}$  for Pulse drive, the Power dissipation is  $-0.75 \times 48 \text{mW}/^\circ\text{C}$ . The product working current must not more than the 60% of the Ifm or Ifp according to the working temperature.

### 11.2 ELECTRICAL/OPTICAL CHARACTERISTICS

(Ta=25°C)

Item	Symbol	Min	Typ	Max	Unit	Condition
Forward Voltage	Vf	4.8	5.0	5.1	V	If=30mA
Reverse Current	Ir		20		uA	Vr=5.0V
Dominant wave length	$\lambda_p$				nm	If=30mA
Spectral Line Half width	$\Delta \lambda$					If=30mA
Luminance	Lv				cd/m <sup>2</sup>	If=30mA
Color Coordinate	X		WHITE			If=30mA
	Y					



Title HYC160210C-bT62L-VA.doc SPECIFICATION	DOC#:	Rev. : R00
	Effective Date: 2011-11-20	

## 12.0 OPERATING PRINCIPLES & METHODS

### 12.1 SYSTEM INTERFACE

This chip has all two kinds of interface type with MPU : 4-bit bus and 8-bit bus. 4-bit bus and 8-bit bus is selected by DL bit in the instruction register. During read or write operation, two 8-bit registers are used. one is data register (DR), the other is instruction register(IR). The data register(DR) is used as temporary data storage place for being written into or read from DDRAM/CGRAM. The target RAM is selected by RAM address setting instruction. Each internal operation, reading from or writing into RAM, is done automatically.

Table 1. Various Kinds of Operations according to RS and R/W Bits

RS	R/W	Operation
L	L	Instruction Write operation (MPU writes Instruction code into IR)
L	H	Read Busy Flag (DB7) and address counter (DB0 - DB6)
H	L	Data Write operation (MPU writes data into DR)
H	H	Data Read operation (MPU reads data from DR)

### 12.2 BUSY FLAG (BF)

When BF = "High", it indicates that the internal operation is being processed. So during this time the next instruction cannot be accepted. BF can be read, when RS = Low and R/W = High (Read Instruction Operation), through DB7 port. Before executing the next instruction, be sure that BF is not High.

### 12.3 ADDRESS COUNTER (AC)

Address Counter(AC) stores DDRAM/CGRAM address, transferred from IR. After writing into (reading from) DDRAM/CGRAM, AC is automatically increased (decreased) by 1. When RS = "Low" and R/W = "High", AC can be read through DB0 – DB6 ports.

### 12.4 DISPLAY DATA RAM(DDRAM)

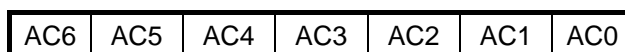

DDRAM Address

In case of 2 line display, the address range of DDRAM is 00H – 0FH, 40H – 4FH.

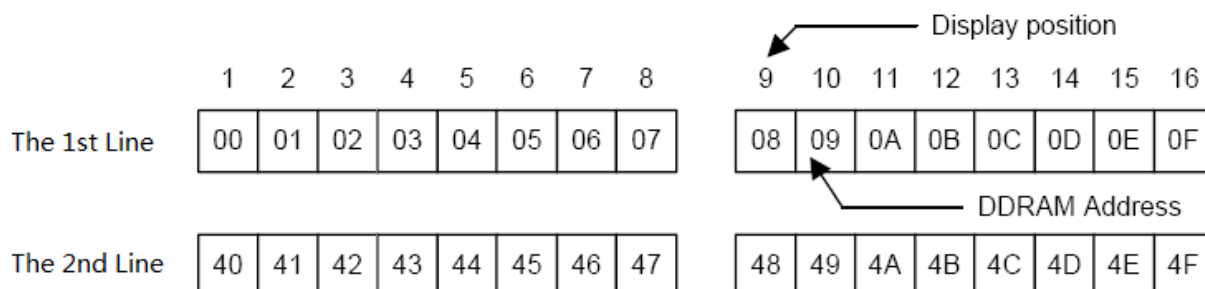



## 12.4 CHARACTER LIST

(English / Japan)

b7-b4 b3-b0	0000	0001	0010	0011	0100	0101	0110	0111	1000	1001	1010	1011	1100	1101	1110	1111
0000	CG RAM (1)			0	1	2	3	4				5	6	7	8	9
0001	(2)	!	1	A	a	9					0	7	7	4	3	9
0010	(3)		"	2	B	R	b	r			1	4	9	7	8	0
0011	(4)		#	3	C	S	c	s			2	9	7	7	8	0
0100	(5)		*	4	D	T	d	t			3	7	7	7	7	0
0101	(6)		%	5	E	U	e	u			4	7	7	7	7	0
0110	(7)		&	6	F	V	f	v			5	7	7	7	7	0
0111	(8)		^	7	G	W	g	w			6	7	7	7	7	0
1000	(1)		<	8	H	X	h	x			7	7	7	7	7	0
1001	(2)		>	9	I	Y	i	y			8	7	7	7	7	0
1010	(3)		*	:	J	Z	j	z			9	7	7	7	7	0
1011	(4)		+	;	K	L	k	l			0	7	7	7	7	0
1100	(5)		.	<	L	*	l	l			1	7	7	7	7	0
1101	(6)		-	=	M	J	m	j			2	7	7	7	7	0
1110	(7)		.	>	N	^	n	^			3	7	7	7	7	0
1111	(8)		/	?	O	_	o	e			4	7	7	7	7	0



Title HYC160210C-bT62L-VA.doc SPECIFICATION	DOC#:	Rev. : R00
	Effective Date: 2011-11-20	

## 13.0 INSTRUCTION DESCRIPTION

### 13.1 INSTRUCTION TABLE

Instruction	Instruction Code										Description Instruction Code
	RS	R/W	DB7	DB6	DB5	DB4	DB3	DB2	DB1	DB0	
Clear Display	0	0	0	0	0	0	0	0	0	1	Write 20H" to DDRAM. and set DDRAM address to "00H" from AC. "
Return Home	0	0	0	0	0	0	0	0	1	X	Set DDRAM address to 00H" from AC and return cursor to its original position if shifted. The contents of DDRAM are not changed. "
Entry Mode Set	0	0	0	0	0	0	0	1	I/D	SH	Assign cursor moving direction and make shift of entire display enable.
Display ON/OFF Control	0	0	0	0	0	0	1	D	C	B	Set display(D), cursor(C), and blinking of cursor(B) on/off control bit.
Cursor or Display Shift	0	0	0	0	0	1	S/C	R/L	X	X	Set cursor moving and display shift control bit, and the direction, without changing DDRAM data.
Function Set	0	0	0	0	1	DL	N	F	X	X	Set interface data length (DL : 4-bit/8-bit), numbers of display line (N : 1-line/2-line), display font type(F : 5 X 8 dots/ 5 X 11 dots)
Set CGRAM Address	0	0	0	1	AC5	AC4	AC3	AC2	AC1	AC0	Set CGRAM address in address counter.
Set DDRAM Address	0	0	1	AC6	AC5	AC4	AC3	AC2	AC1	AC0	Set DDRAM address in address counter.
Read Busy Flag and Address	0	1	BF	AC6	AC5	AC4	AC3	AC2	AC1	AC0	Whether during internal operation or not can be known by reading BF. The contents of address counter can also be read.
Write Data to RAM	1	0	D7	D6	D5	D4	D3	D2	D1	D0	Write data into internal RAM (DDRAM/CGRAM).
Read Data from RAM	1	1	D7	D6	D5	D4	D3	D2	D1	D0	Read data from internal RAM (DDRAM/CGRAM).





Title HYC160210C-bT62L-VA.doc SPECIFICATION	DOC#:	Rev. : R00
	Effective Date: 2011-11-20	

## 13.2 DESCRIPTION OF INSTRUCTION

### 1) Clear Display

RS	R/W	DB7	DB6	DB5	DB4	DB3	DB2	DB1	DB0
0	0	0	0	0	0	0	0	0	1

Clear all the display data by writing "20H" (space code) to all DDRAM address, and set DDRAM address to "00H" into AC (address counter). Return cursor to the original status, namely, bring the cursor to the left edge on first line of the display. Make entry mode increment (I/D = "1").

### 2) Return Home

RS	R/W	DB7	DB6	DB5	DB4	DB3	DB2	DB1	DB0
0	0	0	0	0	0	0	0	1	-

Return Home is cursor return home instruction. Set DDRAM address to "00H" into the address counter. Return cursor to its original site and return display to its original status, if shifted. Contents of DDRAM does not change.

### 3) Entry Mode Set

RS	R/W	DB7	DB6	DB5	DB4	DB3	DB2	DB1	DB0
0	0	0	0	0	0	0	1	I/D	SH

Set the moving direction of cursor and display.

#### **I/D : Increment / decrement of DDRAM address (cursor or blink)**

When I/D = "High", cursor/blink moves to right and DDRAM address is increased by 1.

When I/D = "Low", cursor/blink moves to left and DDRAM address is decreased by 1.

\* CGRAM operates the same as DDRAM, when read from or write to CGRAM.

#### **SH: Shift of entire display**

When DDRAM read (CGRAM read/write) operation or SH = "Low", shift of entire display is not performed.

If SH = "High" and DDRAM write operation, shift of entire display is performed according to I/D value (I/D = "1" : shift left, I/D = "0" : shift right).

### 4) Display ON / OFF Control

RS	R/W	DB7	DB6	DB5	DB4	DB3	DB2	DB1	DB0
0	0	0	0	0	0	1	D	C	B

Control display/cursor/blink ON/OFF 1 bit register.

#### **D : Display ON/OFF Control Bit**



Title HYC160210C-bT62L-VA.doc SPECIFICATION	DOC#:	Rev. : R00
	Effective Date: 2011-11-20	

When D = "High", entire display is turned on.

When D = "Low", display is turned off, but display data is remained in DDRAM.

**C : Cursor ON/OFF Control Bit**

When C = "High", cursor is turned on.

When C = "Low", cursor is disappeared in current display, but I/D register remains its data.

**B : Cursor Blink ON/OFF Control Bit**

When B = "High", cursor blink is on, that performs alternate between all the high data and display character at the cursor position.

When B = "Low", blink is off.

5) Cursor or Display Shift

RS	R/W	DB7	DB6	DB5	DB4	DB3	DB2	DB1	DB0
0	0	0	0	0	1	S/C	R/L	-	-

Shifting of right/left cursor position or display without writing or reading of display data. This instruction is used to correct or search display data (Refer to table 6). During 2-line mode display, cursor moves to the 2nd line after the 40th digit of the 1st line. Note that display shift is performed simultaneously in all the lines. When displayed data is shifted repeatedly, each line is shifted individually. When display shift is performed, the contents of the address counter are not changed.

S/C	R/L	Operation
0	0	Shift cursor to the left, AC is decreased by 1
0	1	Shift cursor to the right, AC is increased by 1
1	0	Shift all the display to the left, cursor moves according to the display
1	1	Shift all the display to the right, cursor moves according to the display

6) Function Set

RS	R/W	DB7	DB6	DB5	DB4	DB3	DB2	DB1	DB0
0	0	0	0	1	DL	N	F	-	-

**DL : Interface Data Length Control Bit**

When DL = "High", it means 8-bit bus mode with MPU.

When DL = "Low", it means 4-bit bus mode with MPU. So to speak, DL is a signal to select 8-bit or 4-bit bus mode. When 4-bit bus mode, it needs to transfer 4-bit data by two times.

**N : Display Line Number Control Bit**

When N = "Low", it means 1-line display mode.

When N = "High", 2-line display mode is set.

**F : Display Font Type Control Bit**

When F = "Low", it means 5x8 dots format display mode

When F = "High", 5x11 dots format display mode.



Title HYC160210C-bT62L-VA.doc SPECIFICATION	DOC#:	Rev. : R00
	Effective Date: 2011-11-20	

#### 7) Set CGRAM Address

RS	R/W	DB7	DB6	DB5	DB4	DB3	DB2	DB1	DB0
0	0	0	1	AC5	AC4	AC3	AC2	AC1	AC0

Set CGRAM address to AC. This instruction makes CGRAM data available from MPU.

#### 8) Set DDRAM Address

RS	R/W	DB7	DB6	DB5	DB4	DB3	DB2	DB1	DB0
0	0	1	AC6	AC5	AC4	AC3	AC2	AC1	AC0

Set DDRAM address to AC. This instruction makes DDRAM data available from MPU. When 1-line display mode(N = 0), DDRAM address is from "00H" to "4FH". In 2-line display mode (N = 1), DDRAM address in the 1st line is from "00H" to "27H", and DDRAM address in the 2nd line is from "40H" to "67H".

#### 9) Read Busy Flag & Address

RS	R/W	DB7	DB6	DB5	DB4	DB3	DB2	DB1	DB0
0	1	BF	AC6	AC5	AC4	AC3	AC2	AC1	AC0

This instruction shows whether S6A0069 is in internal operation or not. If the resultant BF is High, it means the internal operation is in progress and you have to wait until BF to be Low, and then the next instruction can be performed. In this instruction you can read also the value of address counter.

#### 10) Write Data to RAM

RS	R/W	DB7	DB6	DB5	DB4	DB3	DB2	DB1	DB0
1	0	D7	D6	D5	D4	D3	D2	D1	D0

Write binary 8-bit data to DDRAM/CGRAM. The selection of RAM from DDRAM, CGRAM, is set by the previous address set instruction (DDRAM address set, CGRAM address set). RAM set instruction can also determine the AC direction to RAM. After write operation, the address is automatically increased/decreased by 1, according to the entry mode.

#### 11) Read Data from RAM

RS	R/W	DB7	DB6	DB5	DB4	DB3	DB2	DB1	DB0
1	1	D7	D6	D5	D4	D3	D2	D1	D0

Read binary 8-bit data from DDRAM/CGRAM. The selection of RAM is set by the previous address set instruction. If address set instruction of RAM is not performed before this instruction, the

	Title HYC160210C-bT62L-VA.doc SPECIFICATION	DOC#:	Rev. : R00
		Effective Date: 2011-11-20	

data that read first is invalid, because the direction of AC is not determined. If you read RAM data several times without RAM address set instruction before read operation, you can get correct RAM data from the second, but the first data would be incorrect, because there is no time margin to transfer RAM data. In case of DDRAM read operation, cursor shift instruction plays the same role as DDRAM address set instruction : it also transfer RAM data to output data register. After read operation address counter is automatically increased/decreased by 1 according to the entry mode. After CGRAM read operation, display shift may not be executed correctly.

NOTE: In case of RAM write operation, after this AC is increased/decreased by 1 like read operation. In this time, AC indicates the next address position, but you can read only the previous data by read instruction.

	Title	DOC#:	Rev. : R00
	HYC160210C-bT62L-VA.doc SPECIFICATION	Effective Date: 2011-11-20	

## 14.0 QUALITY GUARANTEE

### 14.1 ACCEPTABLE QUALITY LEVEL

Inspection items	Sampling procedures	AQL
Visual-operating (Electro-optical)	GB2828-81 Inspection level II Normal inspection Single sample inspection	0.65
Visual-not operating	GB2828-81 Inspection level II Normal inspection Single sample inspection	1.5
Dimension measurement	GB2828-81 Inspection level II Normal inspection Single sample inspection	1.5

### 14.2 Conditions of Cosmetic Inspection

- Environmental condition

The inspection should be performed at the 1m of height from the LCD module under 2 pieces of 40W white fluorescent lamps (Normal temperature 20~25°C and normal humidity 60±15%RH).

- Inspection method

The visual check should be performed vertically at more than 30cm distance from the LCD panel.

- Driving voltage

The V0 value which the most optimal contrast can be obtained near the specified V0 in the specification. (Within ±0.5V of the typical value at 25°C.).

### 14.3 Definition of inspection zone in LCD

Zone A: character/Digit area

Zone B: viewing area except Zone A (ZoneA+ZoneB=minimum Viewing area)

Zone C: Outside viewing area (invisible area after assembly in customer's product)

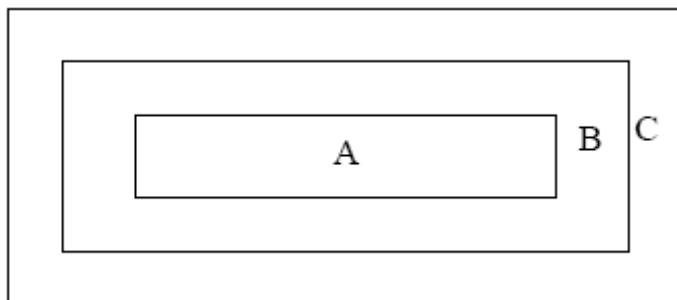

Note: As a general rule, visual defects in Zone C are permissible, when it is no trouble for quality and assembly of customer's product.

	Title HYC160210C-bT62L-VA.doc SPECIFICATION	DOC#:	Rev. : R00
		Effective Date: 2011-11-20	

## 14.4 Inspection Standard

### ● Major Defect

Item No	Items to be inspected	Inspection Standard	Classification of defects
1	All functional defects	1) No display 2) Display abnormally 3) Missing vertical, horizontal segment 4) Short circuit 5) Back-light no lighting, flickering and abnormal lighting.	Major
2	Missing	Missing component	
3	Outline dimension	Overall outline dimension beyond the drawing is not allowed.	

### ● Module Cosmetic Criteria

No.	Item	Judgment Criterion	Partition
1	Difference in Spec.	None allowed	Major
2	Pattern peeling	No substrate pattern peeling and floating	Major
3	Soldering defects	No soldering missing No soldering bridge No cold soldering	Major Major Minor
4	Resist flaw on substrate	Invisible copper foil ( $\varnothing 0.5\text{mm}$ or more) on substrate pattern	Minor
5	Accretion of metallic Foreign matter	No soldering dust No accretion of metallic foreign matters (Not exceed $\varnothing 0.2\text{mm}$ )	Minor Minor
6	Stain	No stain to spoil cosmetic badly	Minor
7	Plate discoloring	No plate fading, rusting and discoloring	Minor
8	1. Solder amount Lead parts	a. Soldering side of PCB Solder to form a 'Filet' all around the lead. Solder should not hide the lead form perfectly. (too much) b. Components side ( In case of 'Through Hole PCB' ) Solder to reach the Components side of PCB.	Minor
	2. Flat packages	Either 'Toe' (A) or 'Seal' (B) of the lead to be covered by 'Filet'. Lead form to be assume over solder.	

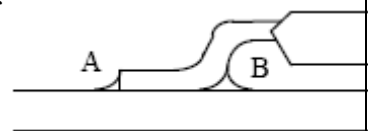
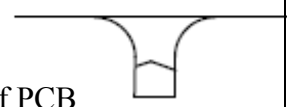
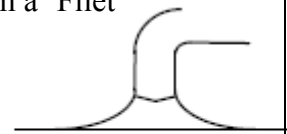

	Title HYC160210C-bT62L-VA.doc SPECIFICATION	DOC#:	Rev. : R00
		Effective Date: 2011-11-20	

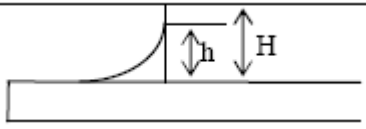
No.	Item	Judgment Criterion	Partition
8	3. Chips	$(3/2) H \geq h \geq (1/2) H$ 	Minor

● **Screen Cosmetic Criteria (Non-Operating)**

No.	Defect	Judgement Criterion	Partition															
1	Spots	In accordance with <i>Screen Cosmetic Criteria (Operating) No.1.</i>	Minor															
2	Lines	In accordance with <i>Screen Cosmetic Criteria (Operating) No.2.</i>	Minor															
3	Bubbles in polarizer	<table border="1" style="margin-left: auto; margin-right: auto;"> <thead> <tr> <th>Size : d</th> <th>mm</th> <th>Acceptable Qty in active area</th> </tr> </thead> <tbody> <tr> <td>d</td> <td>≤ 0.3</td> <td>Disregard</td> </tr> <tr> <td>0.3 &lt; d</td> <td>≤ 1.0</td> <td>3</td> </tr> <tr> <td>1.0 &lt; d</td> <td>≤ 1.5</td> <td>1</td> </tr> <tr> <td>1.5 &lt; d</td> <td></td> <td>0</td> </tr> </tbody> </table>	Size : d	mm	Acceptable Qty in active area	d	≤ 0.3	Disregard	0.3 < d	≤ 1.0	3	1.0 < d	≤ 1.5	1	1.5 < d		0	Minor
Size : d	mm	Acceptable Qty in active area																
d	≤ 0.3	Disregard																
0.3 < d	≤ 1.0	3																
1.0 < d	≤ 1.5	1																
1.5 < d		0																
4	Scratch	In accordance with spots and lines operating cosmetic criteria. When the light reflects on the panel surface, the scratches are not to be remarkable.	Minor															
5	Allowable density	Above defects should be separated more than 30mm each other.	Minor															
6	Coloration	Not to be noticeable coloration in the viewing area of the LCD panels. Back-lit type should be judged with back-lit on state only.	Minor															
7	Contamination	Not to be noticeable.	Minor															

Note: Size : d = (long length + short length) / 2



● Screen Cosmetic Criteria (Operating)

No.	Defect	Judgment Criterion	Partition																				
1	Spots	<p>A) Clear</p> <table border="1"> <thead> <tr> <th>Size : d mm</th> <th>Acceptable Qty in active area</th> </tr> </thead> <tbody> <tr> <td><math>d \leq 0.1</math></td> <td>Disregard</td> </tr> <tr> <td><math>0.1 &lt; d \leq 0.2</math></td> <td>6</td> </tr> <tr> <td><math>0.2 &lt; d \leq 0.3</math></td> <td>2</td> </tr> <tr> <td><math>0.3 &lt; d</math></td> <td>0</td> </tr> </tbody> </table> <p>Note : Including pin holes and defective dots which must be within one pixel size.</p> <p>B) Unclear</p> <table border="1"> <thead> <tr> <th>Size : d mm</th> <th>Acceptable Qty in active area</th> </tr> </thead> <tbody> <tr> <td><math>d \leq 0.2</math></td> <td>Disregard</td> </tr> <tr> <td><math>0.2 &lt; d \leq 0.5</math></td> <td>6</td> </tr> <tr> <td><math>0.5 &lt; d \leq 0.7</math></td> <td>2</td> </tr> <tr> <td><math>0.7 &lt; d</math></td> <td>0</td> </tr> </tbody> </table>	Size : d mm	Acceptable Qty in active area	$d \leq 0.1$	Disregard	$0.1 < d \leq 0.2$	6	$0.2 < d \leq 0.3$	2	$0.3 < d$	0	Size : d mm	Acceptable Qty in active area	$d \leq 0.2$	Disregard	$0.2 < d \leq 0.5$	6	$0.5 < d \leq 0.7$	2	$0.7 < d$	0	Minor
Size : d mm	Acceptable Qty in active area																						
$d \leq 0.1$	Disregard																						
$0.1 < d \leq 0.2$	6																						
$0.2 < d \leq 0.3$	2																						
$0.3 < d$	0																						
Size : d mm	Acceptable Qty in active area																						
$d \leq 0.2$	Disregard																						
$0.2 < d \leq 0.5$	6																						
$0.5 < d \leq 0.7$	2																						
$0.7 < d$	0																						
2	Lines	<p>A) Clear</p> <p>Note :</p> <ul style="list-style-type: none"> <li>( ) - Acceptable Qty in active area</li> <li>L - Length (mm)</li> <li>W - Width (mm)</li> <li><math>\infty</math> - Disregard</li> </ul> <p>B) Unclear</p> <p>‘Clear’ = The shade and size are not changed by Vop. ‘Unclear’ = The shade and size are changed by Vop.</p>	Minor																				

Note: Size : d = (long length + short length) / 2

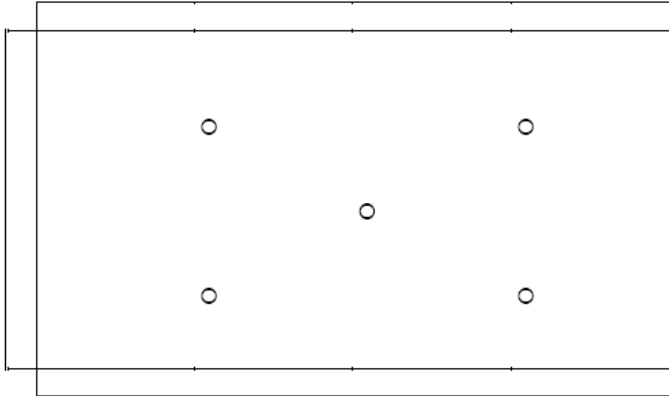

● Screen Cosmetic Criteria (Operating) (Continued)

No.	Defect	Judgment Criterion	Partition
3	Rubbing line	Not to be noticeable.	Minor
4	Allowable density	Above defects should be separated more than 10mm each other.	Minor
5	Rainbow	Not to be noticeable.	Minor
6	Dot size	To be 95% ~ 105% of the dot size (Typ.) in drawing. Partial defects of each dot (ex. pin-hole) should be treated as pot'. (see <i>Screen Cosmetic Criteria (Operating) No.1</i> )	Minor
7	Uneven brightness (only back-lit type module)	<p>Uneven brightness must be <math>B_{MAX} / B_{MIN} \leq 2</math></p> <ul style="list-style-type: none"> <li>- <math>B_{MAX}</math> : Max. value by measure in 5 points</li> <li>- <math>B_{MIN}</math> : Min. value by measure in 5 points</li> </ul> <p>Divide active area into 4 vertically and horizontally. Measure 5 points shown in the following figure.</p>  <p>○ : Measuring points</p>	Minor

Note :

- (1) The limit samples for each item have priority.
- (2) Complex defects are defined item by item, but if the numbers of defects are defined in above table, the total number should not exceed 10.
- (3) In case of 'concentration', even the spots or the lines of 'disregarded' size should not allowed. Following three situations should be treated as 'concentration'.
  - 7 or over defects in circle of  $\varnothing 5\text{mm}$ .
  - 10 or over defects in circle of  $\varnothing 10\text{mm}$ .
  - 20 or over defects in circle of  $\varnothing 20\text{mm}$ .



Title HYC160210C-bT62L-VA.doc SPECIFICATION	DOC#:	Rev. : R00
	Effective Date: 2011-11-20	

## 15.0 RELIABILITY

### 15.1 Content of Reliability Test

No.	Test Item	Test Condition	Inspection after test
1	High Temperature Storage	80°C±2°C/200 hours	Inspection after 2~4hours storage at room temperature, the sample shall be free from defects: 1.Air bubble in the LCD; 2.Sealleak; 3.Non-display; 4.missing segments; 5.Glass crack; 6.Current Idd is twice higher than initial value.
2	Low Temperature Storage	-30°C±2°C/200 hours	
3	High Temperature Operating	70°C±2°C/120 hours	
4	Low Temperature Operating	-20°C±2°C/120 hours	
5	Temperature Cycle	-20°C±2°C~25~70°C±2°C×10cycles (30min.) (5min.) (30min.)	
6	High Temperature Humidity operation /	50°C±5°C×90%RH/120 hours	
7	Vibration Test	Frequency : 10Hz~55Hz~10Hz Amplitude : 1.5mm, X , Y , Z direction for total 3hours (Packing condition)	
8	Drooping test	Drop to the ground from 1m height, one time, and every side of carton. (Packing condition)	
9	Static electricity test	Voltage:±8KV R: 330Ω C: 150pF Air discharge, 10time	
Remark: 1. The test samples should be applied to only one test item. 2. Sample size for each test item is 5~10pcs. 3. For Damp Proof Test, Pure water(Resistance>10MΩ) should be used. 4. In case of malfunction defect caused by ESD damage, if it would be recovered to normal state after resetting, it would be judge as a good part. 5. EL evaluation should be excepted from reliability test with humidity and temperature: Some defects such as black spot/blemish can happen by natural chemical reaction with humidity and Fluorescence EL has. 6. Failure Judgment Criterion: Basic Specification, Electrical Characteristic, Mechanical Characteristic, Optical Characteristic.			

	Title HYC160210C-bT62L-VA.doc SPECIFICATION	DOC#:	Rev. : R00
		Effective Date: 2011-11-20	

## 16.0 PRECAUTIONS FOR USING LCD MODULES

### 16.1 Handling Precautions

(1) The display panel is made of glass. Do not subject it to a mechanical shock by dropping it or impact.

(2) If the display panel is damaged and the liquid crystal substance leaks out, be sure not to get any in your mouth. If the substance contacts your skin or clothes, wash it off using soap and water.

(3) Do not apply excessive force to the display surface or the adjoining areas since this may cause the color tone to vary.

(4) The polarizer covering the display surface of the LCD module is soft and easily scratched. Handle this polarizer carefully.

(5) If the display surface becomes contaminated, breathe on the surface and gently wipe it with a soft dry cloth. If it is heavily contaminated, moisten cloth with one of the following solvents:

- Isopropyl alcohol
- Ethyl alcohol

(6) Solvents other than those above-mentioned may damage the polarizer. Especially, do not use the following.

- Water
- Ketone
- Aromatic solvents

(7) Exercise care to minimize corrosion of the electrode. Corrosion of the electrodes is accelerated by water droplets, moisture condensation or a current flow in a high-humidity environment.

(8) Install the LCD Module by using the mounting holes. When mounting the LCD module make sure it is free of twisting, warping and distortion. In particular, do not forcibly pull or bend the I/O cable or the backlight cable.

(9) Do not attempt to disassemble or process the LCD module.

(10) NC terminal should be open. Do not connect anything.

(11) If the logic circuit power is off, do not apply the input signals.

(12) To prevent destruction of the elements by static electricity, be careful to maintain an optimum work environment.

- Be sure to ground the body when handling the LCD modules.
- Tools required for assembling, such as soldering irons, must be properly grounded.
- To reduce the amount of static electricity generated, do not conduct assembling and other work under dry conditions.
- The LCD module is coated with a film to protect the display surface. Exercise care when peeling off this protective film since static electricity may be generated.

### 16.2 Storage Precautions

When storing the LCD modules, avoid exposure to direct sunlight or to the light of fluorescent lamps. Keep the modules in bags (avoid high temperature / high humidity and low temperatures below 0°C). Whenever possible, the LCD modules should be stored in the same conditions in which they were shipped from our company.

	Title HYC160210C-bT62L-VA.doc SPECIFICATION	DOC#:	Rev. : R00
		Effective Date: 2011-11-20	

### 16.3 Others

Liquid crystals solidify under low temperature (below the storage temperature range) leading to defective orientation or the generation of air bubbles (black or white). Air bubbles may also be generated if the module is subject to a low temperature.

If the LCD modules have been operating for a long time showing the same display patterns, the display patterns may remain on the screen as ghost images and a slight contrast irregularity may also appear. A normal operating status can be regained by suspending use for some time. It should be noted that this phenomenon does not adversely affect performance reliability.

To minimize the performance degradation of the LCD modules resulting from destruction caused by static electricity etc., exercise care to avoid holding the following sections when handling the modules.

- Exposed area of the printed circuit board.
- Terminal electrode sections.

	Title HYC160210C-bT62L-VA.doc SPECIFICATION	DOC#:	Rev. : R00
		Effective Date: 2011-11-20	

## 17.0 USING LCD MODULES

### 17.1 About Liquid Crystal Display Modules

LCD is composed of glass and polarizer. Pay attention to the following items when handling.

(1) Please keep the temperature within specified range for use and storage. Polarization degradation, bubble generation or polarizer peel-off may occur with high temperature and high humidity.

(2) Do not touch, push or rub the exposed polarizer with anything harder than an HB pencil lead (glass, tweezers, etc.).

(3) N-hexane is recommended for cleaning the adhesives used to attach front/rear polarizer and reflectors made of organic substances which will be damaged by chemicals such as acetone, toluene, ethanol and isopropyl alcohol.

(4) When the display surface becomes dusty, wipe gently with absorbent cotton or other soft material like chamois soaked in petroleum benzine. Do not scrub hard to avoid damaging the display surface.

(5) Wipe off saliva or water drops immediately, contact with water over a long period of time may cause deformation or color fading.

(6) Avoid contacting oil and fats.

(7) Condensation on the surface and contact with terminals due to cold will damage, stain or dirty the polarizer. After products are tested at low temperature they must be warmed up in a container before coming is contacting with room temperature air.

(8) Do not put or attach anything on the display area to avoid leaving marks on.

(9) Do not touch the display with bare hands. This will stain the display area and degrade insulation between terminals (some cosmetics are determinate to the polarizer).

(10) As glass is fragile. It tends to become or chipped during handling especially on the edges. Please avoid dropping or jarring.

### 17.2 Installing LCD Modules

The hole in the printed circuit board is used to fix LCM as shown in the picture below. Attend to the following items when installing the LCM.

(1) Cover the surface with a transparent protective plate to protect the polarizer and LC cell.

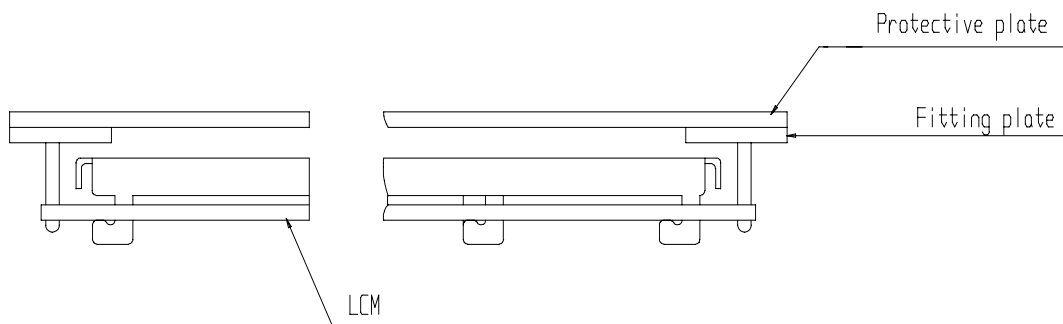

(2) When assembling the LCM into other equipment, the spacer to the bit between the LCM and the fitting plate should have enough height to avoid causing stress to the module surface, refer to the individual specifications for measurements. The measurement tolerance should be  $\pm 0.1$ mm.

	Title HYC160210C-bT62L-VA.doc SPECIFICATION	DOC#:	Rev. : R00
		Effective Date: 2011-11-20	

### 17.3 Electro-Static Discharge Control

Since this module uses a CMOS LSI, the same careful attention should be paid to electrostatic discharge as for an ordinary CMOS IC.

- (1) Make certain that you are grounded when handing LCM.
- (2) Before remove LCM from its packing case or incorporating it into a set, be sure the module and your body have the same electric potential.
- (3) When soldering the terminal of LCM, make certain the AC power source for the soldering iron does not leak.
- (4) When using an electric screwdriver to attach LCM, the screwdriver should be of ground potentiality to minimize as much as possible any transmission of electromagnetic waves produced sparks coming from the commutation of the motor.
- (5) As far as possible make the electric potential of your work clothes and that of the work bench the ground potential.
- (6) To reduce the generation of static electricity be careful that the air in the work is not too dried. A relative humidity of 50%-60% is recommended.

### 17.4 Soldering to the LCM

- (1) Observe the following when soldering lead wire, connector cable and etc. to the LCM.
  - Soldering iron temperature :  $280^{\circ}\text{C} \pm 10^{\circ}\text{C}$ .
  - Soldering time : 3-4 sec.
  - Solder : eutectic solder.

If soldering flux is used, be sure to remove any remaining flux after finishing to soldering operation. (This does not apply in the case of a non-halogen type of flux.) It is recommended that you protect the LCD surface with a cover during soldering to prevent any damage dur to flux spatters.

- (2) When soldering the electroluminescent panel and PC board, the panel and board should not be detached more than three times. This maximum number is determined by the temperature and time conditions mentioned above, though there may be some variance depending on the temperature of the soldering iron.
- (3) When remove the electroluminescent panel from the PC board, be sure the solder has completely melted, the soldered pad on the PC board could be damaged.

### 17.5 Operation

- (1) Viewing angle varies with the change of liquid crystal driving voltage (VO). Adjust VO to show the best contrast.
- (2) Driving the LCD in the voltage above the limit shortens its life.
- (3) Response time is greatly delayed at temperature below the operating temperature range. However, this does not mean the LCD will be out of the order. It will recover when it returns to the specified temperature range.
- (4) If the display area is pushed hard during operation, the display will become abnormal. However, it will return to normal if it is turned off and then back on.
- (5) Condensation on terminals can cause an electrochemical reaction disrupting the terminal circuit.



Title HYC160210C-bT62L-VA.doc SPECIFICATION	DOC#:	Rev. : R00
	Effective Date: 2011-11-20	

Therefore, it must be used under the relative condition of 40°C , 50% RH.

(6) When turning the power on, input each signal after the positive/negative voltage becomes stable.

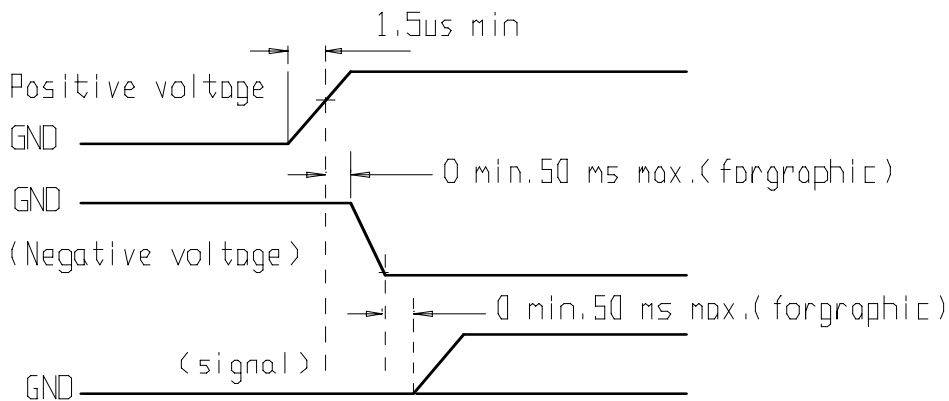

## 17.6 Storage

When storing LCDs as spares for some years, the following precaution are necessary.

(1) Store them in a sealed polyethylene bag. If properly sealed, there is no need for desiccant.

(2) Store them in a dark place. Do not expose to sunlight or fluorescent light, keep the temperature between 0°C and 35°C.

(3) The polarizer surface should not come in contact with any other objects. (We advise you to store them in the container in which they were shipped.)

(4) Environmental conditions:

- Do not leave them for more than 168hrs. at 60°C.
- Should not be left for more than 48hrs. at -20°C.

## 17.7 Safety

(1) It is recommended to crush damaged or unnecessary LCDs into pieces and wash them off with solvents such as acetone and ethanol, which should later be burned.

(2) If any liquid leaks out of a damaged glass cell and comes in contact with the hands, wash off thoroughly with soap and water.

## 17.8 Limited Warranty

Unless agreed between HYDISPLAY and customer, HYDISPLAY will replace or repair any of its LCD modules which are found to be functionally defective when inspected in accordance with HYDISPLAY LCD/LCM acceptance standards (copies available upon request) for a period of one year from date of shipments. Cosmetic/visual defects must be returned to HYDISPLAY within 90 days of shipment. Confirmation of such date shall be based on freight documents. The warranty liability of HYDISPLAY limited to repair and/or replacement on the terms set forth above. HYDISPLAY will not be responsible for any subsequent or consequential events.

	Title HYC160210C-bT62L-VA.doc SPECIFICATION	DOC#:	Rev. : R00
		Effective Date: 2011-11-20	

## 17.9 Return LCM under warranty

No warranty can be granted if the precautions stated above have been disregarded. The typical examples of violations are :

- Broken LCD glass.
- PCB eyelet's damaged or modified.
- PCB conductors damaged.
- Circuit modified in any way, including addition of components.
- PCB tampered with by grinding, engraving or painting varnish.
- Soldering to or modifying the bezel in any manner.

Module repairs will be invoiced to the customer upon mutual agreement. Modules must be returned with sufficient description of the failures or defects. Any connectors or cable installed by the customer must be removed completely without damaging the PCB eyelet, conductors and terminals.



	Title	DOC#:	Rev. : R00
	HYC160210C-bT62L-VA.doc SPECIFICATION	Effective Date: 2011-11-20	

## 18.0 APPENDIX

### 18.1 Initialization Code

```
//Write Instruction data to ST7066U
#pragma disable
void wr_cmd(uchar cmd)
{
    LCD_E=0;
    LCD_RS=0;
    LCD_RW=0;

    DataPort=cmd;
    LCD_E=1;
    LCD_E=0;
    delay(20);
}

//Write Display data to ST7066U
#pragma disable
void wr_dat(uchar dat)
{
    LCD_E=0;
    LCD_RS=1;
    LCD_RW=0;

    DataPort=dat;
    LCD_E=1;
    LCD_E=0;
    delay(20);
}

#pragma disable
void init()
{
    wr_cmd(0x38); //8-bit,2 lines,5X8 dots
    wr_cmd(0x08); //display off
    wr_cmd(0x01); //clear disram, set DDRAM address 0
    delay(20);
    wr_cmd(0x06); //increment by 1, no shift
    wr_cmd(0x0C); //display on, cursor off, blink off
}

```

## 18.2 Power Supply Circuit Diagram

